

Steps Used with 41" Series Blocks

3-Sided Straight Step

Volume = 4.58 cft
Weight = ±655 lbs

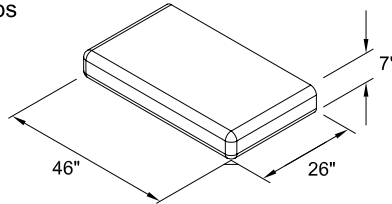

4-Sided 6" Cap Block

Volume = 4.81 cft
Weight = ±688 lbs

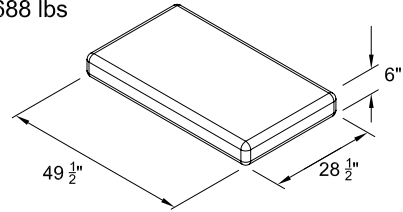

Corner Block Finished on Three Sides Perimeter Free-Standing Series Used with 41" Series Blocks

Garden Corner

Volume = 8.26 cft
Weight = ±1182 lbs

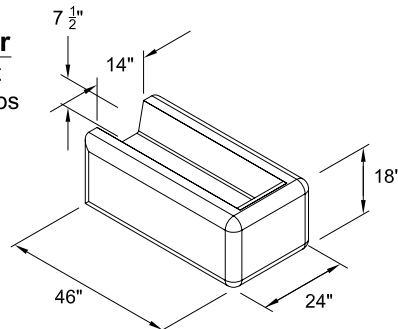

Half Garden Corner

Volume = 4.25 cft
Weight = ±607 lbs

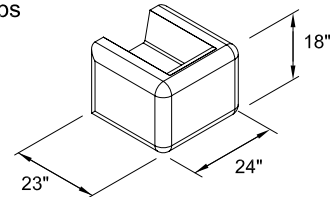

Top Corner

(available with textured top)
Volume = 10.44 cft
Weight = ±1493 lbs

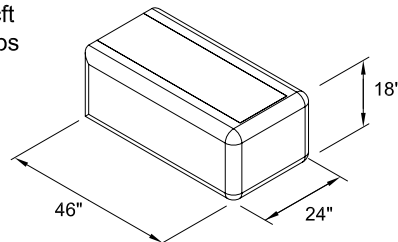

Half Top Corner

(available with textured top)
Volume = 5.19 cft
Weight = ±742 lbs

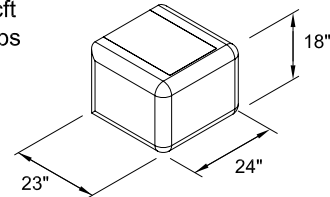

Middle Corner

Volume = 10.51 cft
Weight = ±1502 lbs

(Bottom Corner Block does not have groove)

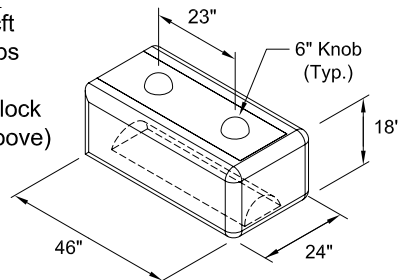

Half Middle Corner

Volume = 5.28 cft
Weight = ±755 lbs

(Half Bottom Corner Block does not have groove)

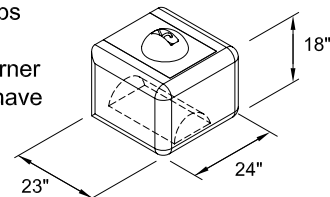

NOTES:

Cobblestone face is 24" wide and limestone face is approximately 23" wide.

Volume calculations are based on the blocks as shown.

Actual weights and volumes will may vary.

Weight shown is based on 143 pcf concrete.

DRAWN BY J. JOHNSON	01/18/07	Redi-Rock® International, LLC	
CHECKED BY			
APPROVED BY		DRAWING FILE Steps and Corners for 41in Series.dwg	REVISION ---
ISSUE DATE		SCALE NO SCALE	SHEET NO. 1 OF 1